

DECAL KIT "USA"
SCHILDERSATZ "USA"
JEU DE PLAQUES "USA"

from No / up to No
WFN5RUG###2036101
WFN5RUG###2036135

Figure
Bild 99707785896
Figure

TADANO
2830-20

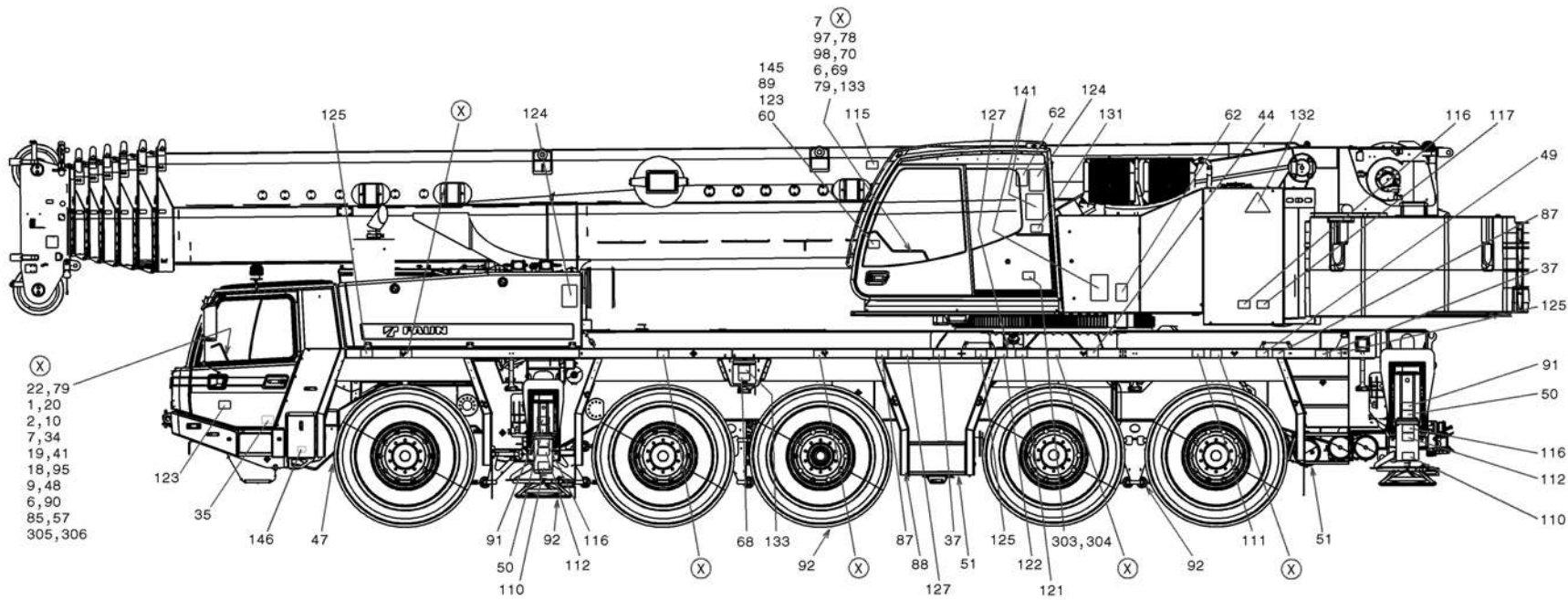

(X) see Figure
siehe Bild
voir Figure
2830-10...12

DECAL KIT "USA"
SCHILDERSATZ "USA"
JEU DE PLAQUES "USA"

from No / up to No
WFN5RUG###2036101
WFN5RUG###2036135

Figure
Bild 99707785896
Figure

TADANO
2830-20

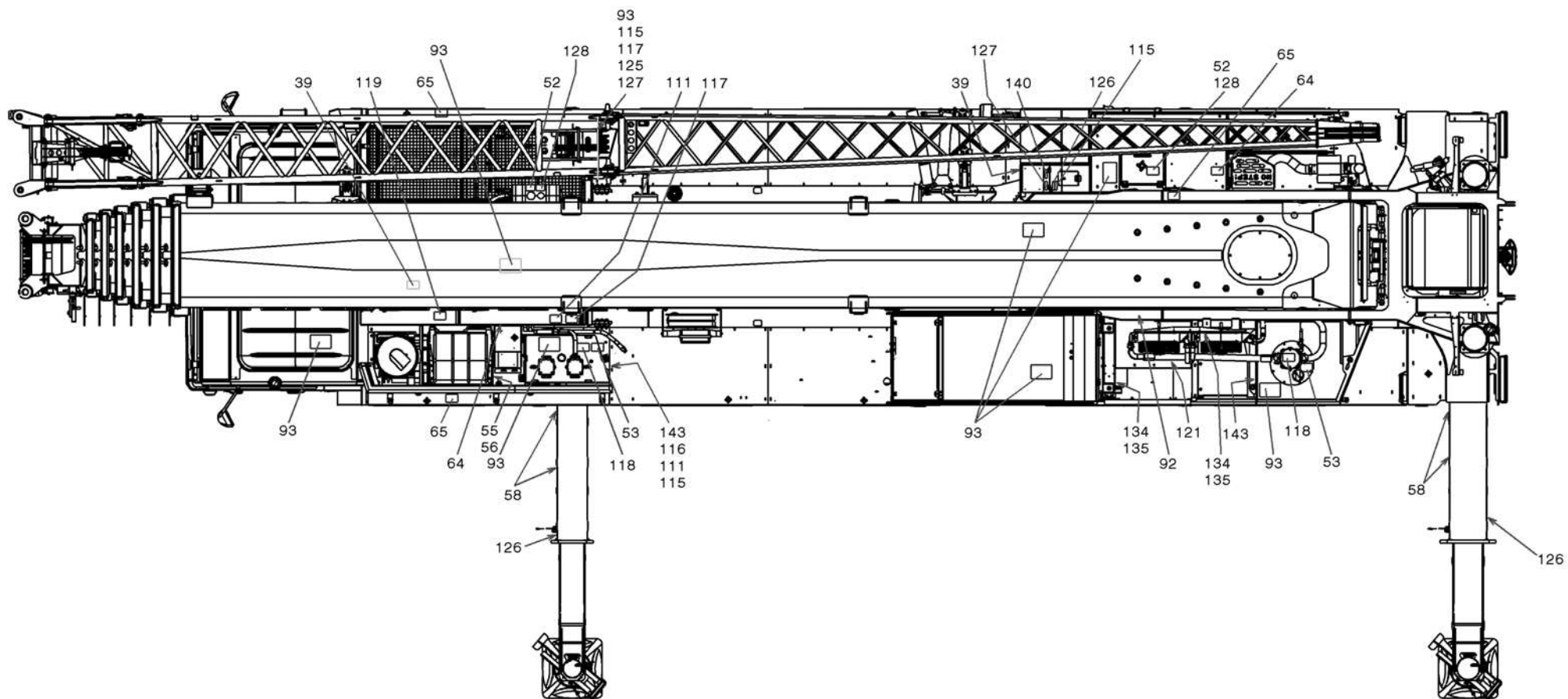

DECAL KIT "USA"
SCHILDERSATZ "USA"
JEU DE PLAQUES "USA"

from No / up to No
WFN5RUG###2036101
WFN5RUG###2036135

Figure
Bild 99707785896
Figure

TADANO
2830-20

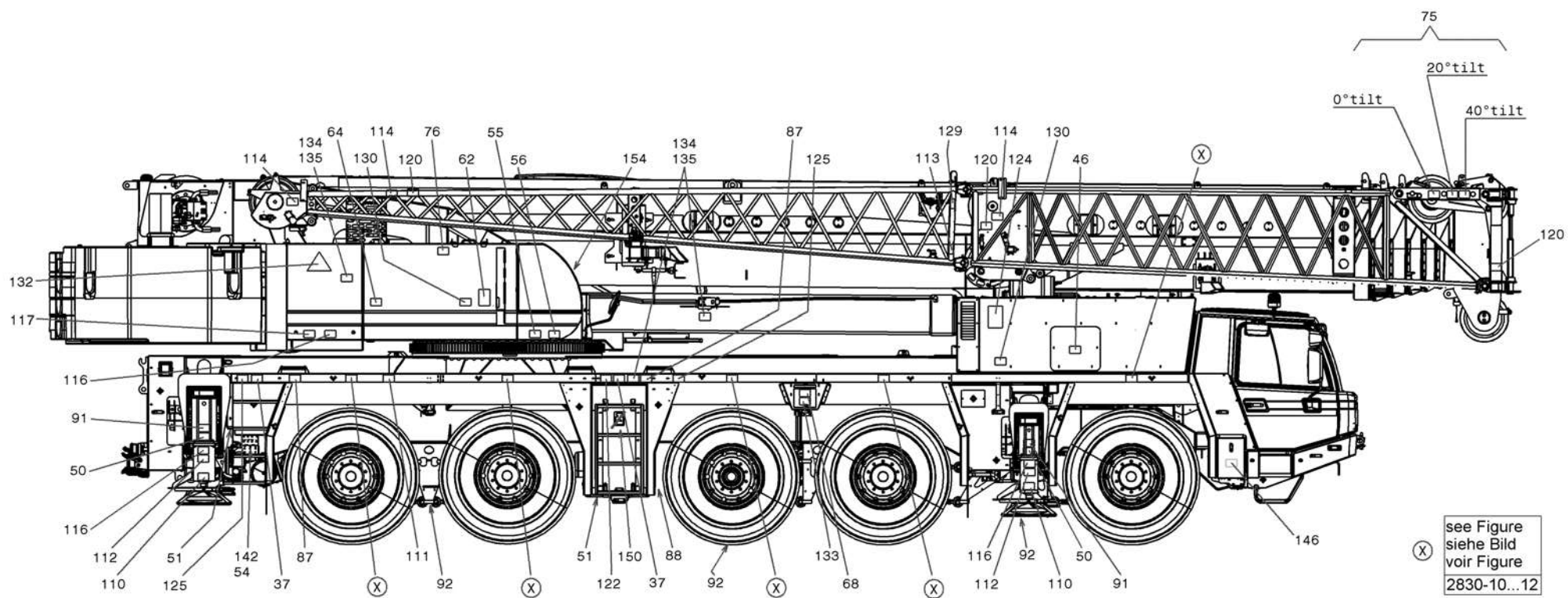

DECAL KIT "USA"
SCHILDERSATZ "USA"
JEU DE PLAQUES "USA"

from No / up to No
WFN5RUG###2036101
WFN5RUG###2036135

Figure
Bild 99707785896
Figure

 **TADANO**
2830-20

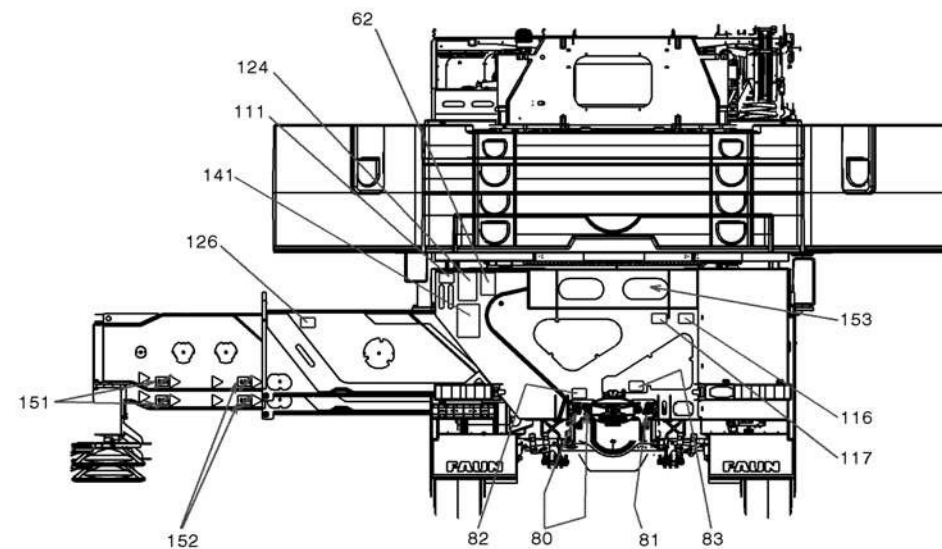
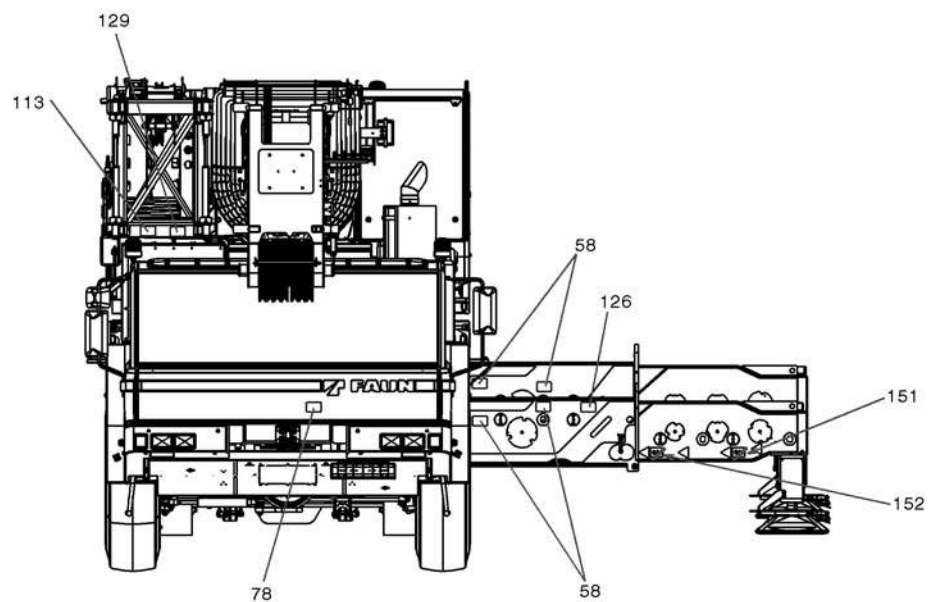

DECAL KIT "USA"
 SCHILDERSATZ "USA"
 JEU DE PLAQUES "USA"

from No / up to No
 WFN5RUG###2036101
 WFN5RUG###2036135

Figure
 Bild 99707785896
 Figure



SPEED - CHART				
Tires 16.00R25 / 20.5R25				
Gear	Off-Road		On-Road	
	mph	km/h	mph	km/h
1 st	2	3	4	6
2 nd	2	3	4	7
3 rd	2	4	5	8
4 th	2	4	6	10
5 th	3	5	7	12
6 th	4	7	9	15
7 th	5	8	11	18
8 th	6	9	13	21
9 th	7	11	16	26
10 th	9	14	19	31
11 th	11	17	24	38
12 th	12	20	29	46
13 th	15	24	35	56
14 th	19	30	42	68
15 th	22	35	50	80
16 th	26	42	53	85
1 st RW	2	3	4	6
2 nd RW	2	3	4	7

DO NOT RUN THE ENGINE OVER 2000 rpm 99707785935

90

MAX. JACK FORCE DURING CRANE OPERATION:
132 TONS (US) 99707792829

91

0°TILT | 20°TILT | 40°TILT

99707785927 | 99707785927 | 99707785927

75

18.37 ft

151

OPERATING AIR PRESSURE
180 PSI 99707792830

51

27.23 ft

152

98







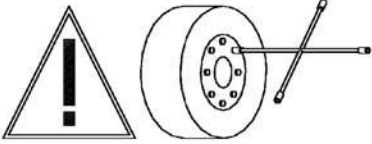
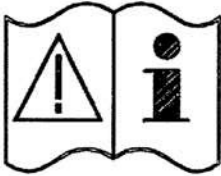
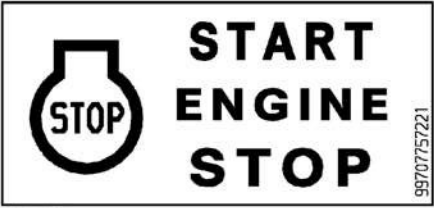

9970777801

DECAL KIT "USA"
 SCHILDERSATZ "USA"
 JEU DE PLAQUES "USA"

from No / up to No
 WFN5RUG###2036101
 WFN5RUG###2036135

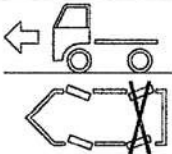
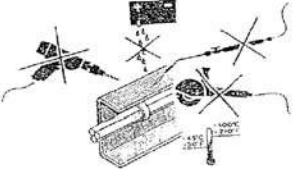
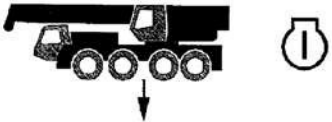
Figure
 Bild 99707785896
 Figure

TADANO
 2830-20

 <p>≈ 50/100/200/...km ≈ 30/60/120/...miles</p> <p>9970715238</p> <p>1</p>	 <p>SEE OPERATORS MANUAL</p> <p>7741359</p> <p>2</p>	 <p>9970757221</p> <p>6</p>	 <p>7741364</p> <p>ENGINE SPEED CONTROL</p> <p>7</p>
 <p>PARKING BRAKE</p> <p>7757220</p> <p>9</p>	<p>WARNING</p>  <p>HAZARDOUS CONDITION CAN CAUSE VEHICLE HANDLING PROBLEMS DIFFERENTIAL LOCK MUST ONLY BE ENGAGED IN OFF - ROAD ROUGH TERRAIN CONDITIONS</p> <p>7757245</p> <p>10</p>	<p>WARNING</p>  <p>7741365</p> <p>LOCK THE REAR AXLE STEERING SYSTEM WHEN TRAVELING ON ROAD OR WITH DOLLY</p> <p>18</p>	<p>CAUTION</p>  <p>PLASTIC BRAKE SYSTEM PIPES BE CAREFUL WHEN WELDING DRILLING AND MOUNTING</p> <p>7741399</p> <p>19</p>
<p>CAUTION</p>  <p>VEHICLE LOWERS ONLY WHEN ENGINE IS RUNNING</p> <p>7757244</p> <p>20</p>	<p>WARNING</p>  <p>DO NOT STAY UNDER OR ON VEHICLE WHEN LOWERING</p> <p>7741356</p> <p>22</p>	<p>CAUTION</p>  <p>DO NOT REMAIN IN CAB WHEN CRANE IS OPERATING</p> <p>7757246</p> <p>34</p>	<p>CAUTION</p>  <p>ENGAGE PARKING HANDBRAKE BEFORE LEAVING CAB.</p> <p>7741361</p> <p>35</p>

DECAL KIT "USA"
 SCHILDERSATZ "USA"
 JEU DE PLAQUES "USA"

from No / up to No
 WFN5RUG###2036101
 WFN5RUG###2036135

Figure
 Bild 99707785896
 Figure

TADANO
 2830-20

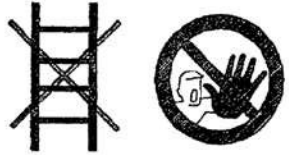
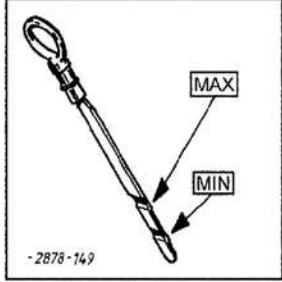
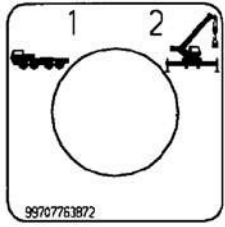
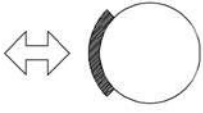



<p>WARNING STOP! NO ACCESS FOR UNAUTHORIZED PERSONNEL</p>  <p>37 7757258</p>	 <p>39</p>	 <p>41</p>	<p>NOTICE TEST CONNECTORS M4 FOR HYDRAULIC SYSTEM SEE OPERATORS MANUAL FOR INSTRUCTIONS</p> <p style="text-align: right;">99707785926</p> <p>44</p>
<p>NOTICE TEST CONNECTORS M3 FOR HYDRAULIC SYSTEM SEE OPERATORS MANUAL FOR INSTRUCTIONS</p> <p style="text-align: right;">99707780259</p> <p>46</p>	<p>NOTICE TEST CONNECTORS M1 + M2 FOR STEERING SYSTEM SEE OPERATORS MANUAL FOR INSTRUCTIONS</p> <p style="text-align: right;">99707757000</p> <p>47</p>	 <p>AIR BRAKE PRESSURE: 120 - 145 PSI</p> <p style="text-align: right;">99707780263</p> <p>48</p>	<p>NOTICE TEST CONNECTOR M5 FOR STEERING SYSTEM SEE OPERATORS MANUAL FOR INSTRUCTIONS</p> <p style="text-align: right;">99707757002</p> <p>49</p>
<p>WARNING</p> <p>INSTALL ALL PINS IN EACH OUTRIGGER, OUTRIGGER PAD AND JIB BEFORE STARTING TO TRAVEL</p> <p style="text-align: right;">7741394</p> <p>50</p>	<p>OPERATING AIR PRESSURE 220 PSI</p> <p style="text-align: right;">7741386</p> <p>51</p>	<p>NOTICE COOLING FLUID SEE OPERATORS MANUAL FOR INSTRUCTIONS</p> <p style="text-align: right;">7741396</p> <p>52</p>	<p>NOTICE HYDRAULIC FLUID SEE OPERATORS MANUAL FOR INSTRUCTIONS</p> <p style="text-align: right;">7741397</p> <p>53</p>

DECAL KIT "USA"
 SCHILDERSATZ "USA"
 JEU DE PLAQUES "USA"

from No / up to No
 WFN5RUG###2036101
 WFN5RUG###2036135

Figure
 Bild 99707785896
 Figure

TADANO
 2830-20

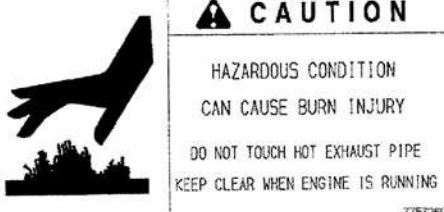
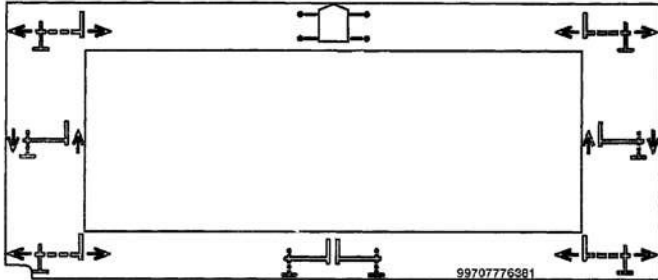
 <p style="text-align: right;">57</p>	 <p style="text-align: center;">58</p>	<p style="text-align: center;">NOTICE</p> <p style="text-align: center;">TEST CONNECTORS FOR AIR BRAKE SYSTEM A - H SEE OPERATORS MANUAL FOR INSTRUCTIONS 3970778592E</p> <p style="text-align: center;">54</p>	
 <p style="text-align: center;">62</p>	 <p style="text-align: center;">146</p>	 <p style="text-align: center;">64</p>	<p style="text-align: center;">EXTERNAL BATTERY STARTING PLUG SOCKET 24V / DC 7741391</p> <p style="text-align: center;">55</p>
	 <p style="text-align: center;">60</p>	<p style="text-align: center;">BATTERY CHARGING PLUG SOCKET 24V / DC 7741392</p> <p style="text-align: center;">56</p>	

DECAL KIT "USA"
 SCHILDERSATZ "USA"
 JEU DE PLAQUES "USA"

from No / up to No
 WFN5RUG###2036101
 WFN5RUG###2036135

Figure
 Bild 99707785896
 Figure

TADANO
 2830-20





 <p>WARNING</p> <p>DO NOT STEP HERE</p> <p>7757214</p> <p>65</p>	<p>OUTRIGGER CONTROL BOX</p> <p>7757213</p> <p>68</p>	 <p>WARNING</p> <p>STEERING FUNCTIONS ONLY WHILE ENGINE IS RUNNING</p> <p>7757267</p> <p>69</p>	<p>FREE</p>  <p>7757286</p> <p>SWIMS</p>  <p>LOCKED</p> <p>70</p>	
 <p>WARNING</p> <p>HAZARDOUS CONDITION CAN CAUSE SEVERE INJURY ENSURE JIB PIVOT PINS ARE INSTALLED AT BOOM HEAD BEFORE DISCONNECTING JIB FROM STOWING BRACKET</p> <p>7757337</p> <p>113</p>	<p>SWING BRAKE</p>  <p>7757262</p> <p>74</p>	 <p>WARNING</p> <p>HAZARDOUS CONDITION CAN CAUSE SEVERE INJURY USE A TAGLINE TO PREVENT RAPID SURING OF JIB FROM BOOM WHEN JIB IS RELEASED AT STOWING BRACKET</p> <p>7757338</p> <p>114</p>	 <p>LADDER POSITION</p> <p>99707757224</p> <p>76</p>	
<p>ON</p> <p>99707757237</p> <hr/> <p>OFF</p> <p>99707757237</p> <p>77</p>	<p>12V DC</p> <p>7757241</p> <p>78</p>	<p>24V DC</p> <p>7757240</p> <p>79</p>	<p>24V / DC</p> <p>99707757231</p> <p>80</p>	 <p>ANTI-LOCK SYSTEM 24V / DC</p> <p>99707757234</p> <p>81</p>







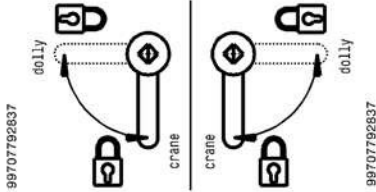
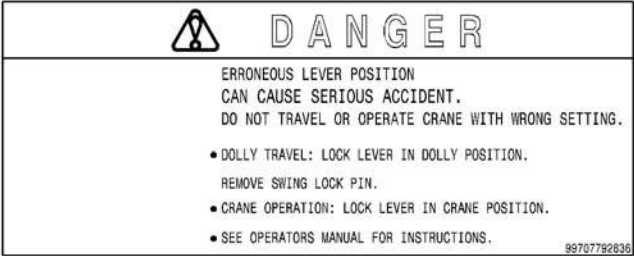

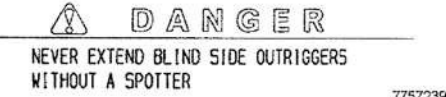
DECAL KIT "USA"
 SCHILDERSATZ "USA"
 JEU DE PLAQUES "USA"

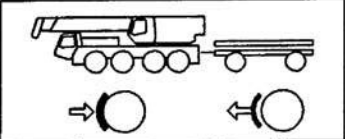
from No / up to No
 WFN5RUG###2036101
 WFN5RUG###2036135

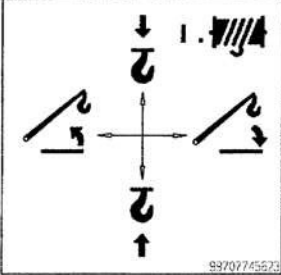
Figure
 Bild 99707785896
 Figure

TADANO
 2830-20

 <p>82</p>	 <p>83</p>	 <p>135</p>	
<p>FASTEN SEAT BELT</p> <p>85 7757227</p>	<p>HANDHOLD</p> <p>87 7757226</p>	 <p>134</p>	
 <p>88 7757223</p>	 <p>89 7757239</p>		







 <p>⚠ DANGER</p> <p>KEEP CLEAR OF LOWERING OR RAISING BOOM TO AVOID SERIOUS INJURY.</p> <p>7757339</p> <p>115</p>	<p>⚠ CAUTION</p> <p>DO NOT USE OXYGEN !</p> <p>DO NOT OPERATE UNIT WITHOUT PROPER NITROGEN GAS PRESSURE RELEASE ALL HYDRAULIC AND GAS PRESSURE BEFORE DISASSEMBLING UNIT SEE SERVICE INSTRUCTIONS FOR ADDITIONAL INFORMATION</p> <p>7757251</p> <p>92</p>	<p>NO STEP</p> <p>7757251</p> <p>93</p>	 <p>Test for parking brake: See operators manual</p> <p>99707757238</p> <p>94</p>
<p>⚠ CAUTION</p>  <p>BEFORE CHANGING OVER TO OPERATION CONTROLLED FROM THE SUPERSTRUCTURE, MAKE SURE THAT:</p> <ol style="list-style-type: none"> 1) TRANSMISSION IS IN NEUTRAL POSITION, 2) HANDBRAKES ARE ENGAGED. <p>99707780260</p> <p>95</p>	<p>NOTICE</p> <p>HYDRAULIC FLUID ONLY</p> <p>READ OPERATORS MANUAL BEFORE SERVICING ALL CYLINDERS MUST BE RETRACTED WHEN CHECKING FLUID LEVEL</p> <p>7757342</p> <p>118</p>	 <p>99707745523</p> <p>97</p>	 <p>⚠ DANGER</p> <p>SWINGING STRUCTURE STAY CLEAR TO PREVENT SEVERE PERSONAL INJURY OR DEATH</p> <p>7757341</p> <p>117</p>
 <p>⚠ DANGER</p> <p>FALLING LOAD OR BOOM CAN CAUSE SEVERE PERSONAL INJURY OR DEATH STAY CLEAR OF LOAD, BLOCK AND BOOM</p> <p>7757340</p> <p>116</p>	 <p>⚠ WARNING</p> <p>HAZARD CAN CAUSE INJURY KEEP CLEAR OF OUTRIGGER WHILE CRANE IS OPERATING</p> <p>7757334</p> <p>110</p>	 <p>⚠ WARNING</p> <p>HAZARD CAN CAUSE INJURY KEEP CLEAR OF CRANE WHILE SWINGING OR TRAVELING</p> <p>7757335</p> <p>111</p>	 <p>⚠ WARNING</p> <p>KEEP CLEAR OF MOVING OUTRIGGER TO PREVENT BODILY INJURY.</p> <p>7757336</p> <p>112</p>

DECAL KIT "USA"
 SCHILDERSATZ "USA"
 JEU DE PLAQUES "USA"

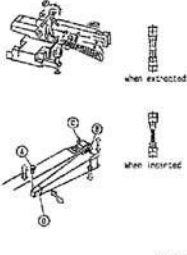
from No / up to No
 WFN5RUG###2036101
 WFN5RUG###2036135

Figure
 Bild 99707785896
 Figure

TADANO
 2830-20

































































 <p>WARNING</p> <p>ROTATING FAN KEEP HANDS AWAY STOP ENGINE TO SERVICE</p> <p>7757343</p> <p>119</p>	<p>CAUTION</p> <p>JIB HANDLING INSTRUCTIONS</p> <p>BEFORE OPERATING CRANE OR TRAVELING ON ROAD, CHECK STOWING PIN (A) AND PIVOT PIN (B). JIB WILL FALL OFF IF TRUCK IS STARTED WITH BOTH PINS OUT OF POSITION.</p> <p>NEVER EXTEND BOOM WHEN BOTH PINS ARE FIRED AT THE SAME TIME. THE BOOM WILL BE DAMAGED.</p> <p>ATC FOR JIB</p> <ol style="list-style-type: none"> 1. INSERT TOP AND BOTTOM PIVOT PIN (B). 2. EXTRACT STOWING PIN (A). 3. DISCONNECT ROPE SOCKET FROM ANCHOR (C). 4. MARK AND ALIGN JIB STRAIGHT AHEAD OF BOOM AND INSERT TOP AND BOTTOM CONNECTING PINS (D). 5. SEW ELECTRICAL CONNECTIONS FOR ANCHOR AND ROPE TALKER DEVICE. (SEE THE WORK VEHICLE MANUAL). <p>ATC STOW JIB, INSERT STOWING PIN (A) TO SECURE JIB TO BOOM AND THEN EXTRACT PIVOT PIN (B). ATTACH ROPE SOCKET TO ANCHOR (C) ONLY AFTER JIB IS COMPLETELY STOWED.</p>  <p>when extracted</p> <p>when inserted</p> <p>7757344</p> <p>120</p>	<p>DIESEL FUEL</p> <p>7757345</p> <p>121</p>	<p>DANGER</p> <p>HAZARDOUS CONDITION</p> <p>CAN CAUSE SEVERE INJURY OR DEATH</p> <p>STAY CLEAR WHEN INFLATING TIRES</p> <p>ALWAYS USE AN AIR CHUCK AND TIRE CAGE</p> <p>RIM SIDE OR LOCK RING CAN BLOW OUT</p> <p>8820725/246</p> <p>122</p>
<p>WARNING</p> <p>DO NOT OPERATE THIS CRANE UNLESS</p> <ul style="list-style-type: none"> - YOU ARE TRAINED IN ITS SAFE OPERATION - YOU KNOW AND FOLLOW THE SAFETY AND OPERATING INSTRUCTIONS CONTAINED IN THE TADANO/FAUN MANUALS - YOU KNOW AND UNDERSTAND LOCAL WORKPLACE RULES AND OSHA RECOMMENDATIONS - AN UNTRAINED OPERATOR SUBJECTS HIMSELF AND OTHERS TO DEATH OR SERIOUS INJURY <p>7757347</p> <p>123</p>	<p>DANGER</p> <p>ELECTROSHOCK HAZARD</p> <p>GET CLEAR BEFORE HANDY OR DEAD.</p> <p>NEVER TOUCH THE CRANE OR TRUCKS OR OTHER EQUIPMENT OF A TRUCK COMPANY OR PLANT. LIVE WIRE CONNECTIONS ARE EXTREMELY DANGEROUS TO LIFE. IT CAN BE FATAL.</p> <p>NEVER TOUCH THE CRANE OR TRUCKS OR OTHER EQUIPMENT OF A TRUCK COMPANY OR PLANT. LIVE WIRE CONNECTIONS ARE EXTREMELY DANGEROUS TO LIFE. IT CAN BE FATAL.</p> <p>NEVER TOUCH THE CRANE OR TRUCKS OR OTHER EQUIPMENT OF A TRUCK COMPANY OR PLANT. LIVE WIRE CONNECTIONS ARE EXTREMELY DANGEROUS TO LIFE. IT CAN BE FATAL.</p> <p>DANGER</p> <p>NEVER TOUCH THE CRANE OR TRUCKS OR OTHER EQUIPMENT OF A TRUCK COMPANY OR PLANT. LIVE WIRE CONNECTIONS ARE EXTREMELY DANGEROUS TO LIFE. IT CAN BE FATAL.</p> <p>NEVER TOUCH THE CRANE OR TRUCKS OR OTHER EQUIPMENT OF A TRUCK COMPANY OR PLANT. LIVE WIRE CONNECTIONS ARE EXTREMELY DANGEROUS TO LIFE. IT CAN BE FATAL.</p> <p>NEVER TOUCH THE CRANE OR TRUCKS OR OTHER EQUIPMENT OF A TRUCK COMPANY OR PLANT. LIVE WIRE CONNECTIONS ARE EXTREMELY DANGEROUS TO LIFE. IT CAN BE FATAL.</p> <p>7757348</p> <p>124</p>	 <p>WARNING</p> <p>HAZARD</p> <p>CAN CAUSE INJURY</p> <p>DO NOT MOUNT OR CLIMB ON CRANE WHILE OPERATING</p> <p>7757349</p> <p>125</p>	 <p>WARNING</p> <p>HAZARD</p> <p>CAN CAUSE INJURY</p> <p>DO NOT MOUNT OR CLIMB ON BOOM JIB OR OUTRIGGER</p> <p>7757350</p> <p>126</p>
 <p>CAUTION</p> <p>DO NOT STUMBLE OVER PROJECTION</p> <p>7757351</p> <p>127</p>	 <p>WARNING</p> <p>DO NOT REMOVE RADIATOR CAP WHEN ENGINE IS HOT.</p> <p>7757352</p> <p>128</p>	<p>WARNING</p> <p>HAZARDOUS CONDITION</p> <p>CAN CAUSE SEVERE INJURY</p> <p>DO NOT REMOVE JIB PIVOT PINS AT BOOM HEAD UNTIL JIB IS PINNED TO STOWING BRACKET</p> <p>7757353</p> <p>129</p>	 <p>WARNING</p> <p>AUTOMATIC FAN START</p> <p>KEEP HANDS AWAY</p> <p>STOP ENGINE TO SERVICE</p> <p>7757354</p> <p>130</p>

DECAL KIT "USA"
 SCHILDERSATZ "USA"
 JEU DE PLAQUES "USA"

from No / up to No
 WFN5RUG###2036101
 WFN5RUG###2036135

Figure
 Bild 99707785896
 Figure

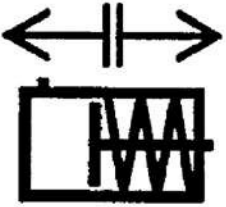
TADANO
 2830-20

<p style="text-align: center;"> DANGER</p> <hr/> <p>HAZARDOUS OPERATION CAN RESULT IN SEVERE INJURY OR DEATH. DO NOT LIFT PERSONNEL REFER TO ANSI B30.56-1991, PARA 5-3.2.2 FOR INSTRUCTIONS.</p> <p style="text-align: right;">7757270</p> <p style="text-align: center;">131</p>	<p style="text-align: right;">132</p> <p style="text-align: center;"></p>	<p style="text-align: center;">BUBBLE MUST BE IN THE CENTER (SEE OPERATORS MANUAL)</p> <p style="text-align: right;">7757298</p> <p style="text-align: center;">133</p>																					
		<p style="text-align: center;"> CAUTION</p> <hr/> <p style="text-align: center;">LOW CLEARANCE BE AWARE OF OVER HEAD OBSTRUCTION</p> <p style="text-align: right;">7757366</p> <p style="text-align: center;">140</p>	<p>7757310</p> <p style="text-align: center;">HAND SIGNALS</p> <table border="1" style="width: 100%; text-align: center;"> <tr> <td> HOIST</td> <td> LOWER</td> <td> USE MAIN HOIST</td> <td> USE WHIPLINE <small>(Over Lifting Point)</small></td> </tr> <tr> <td> RAISE BOOM</td> <td> LOWER BOOM</td> <td> MOVE SLOWLY</td> <td> RAISE THE BOOM AND LOWER THE LOAD</td> </tr> <tr> <td> LOWER THE BOOM AND RAISE THE LOAD</td> <td> SWING</td> <td> STOP</td> <td> EMERGENCY STOP</td> </tr> <tr> <td> TRAVEL</td> <td> DOG EVERYTHING</td> <td> TRAVEL <small>(ONE TRACK)</small></td> <td> TRAVEL <small>(ONE TRACK)</small></td> </tr> <tr> <td> EXTEND BOOM</td> <td> RETRACT BOOM</td> <td> EXTEND BOOM <small>(ONE HAND)</small></td> <td> RETRACT BOOM <small>(ONE HAND)</small></td> </tr> </table> <p style="text-align: center;">141</p>	 HOIST	 LOWER	 USE MAIN HOIST	 USE WHIPLINE <small>(Over Lifting Point)</small>	 RAISE BOOM	 LOWER BOOM	 MOVE SLOWLY	 RAISE THE BOOM AND LOWER THE LOAD	 LOWER THE BOOM AND RAISE THE LOAD	 SWING	 STOP	 EMERGENCY STOP	 TRAVEL	 DOG EVERYTHING	 TRAVEL <small>(ONE TRACK)</small>	 TRAVEL <small>(ONE TRACK)</small>	 EXTEND BOOM	 RETRACT BOOM	 EXTEND BOOM <small>(ONE HAND)</small>	 RETRACT BOOM <small>(ONE HAND)</small>
 HOIST	 LOWER	 USE MAIN HOIST	 USE WHIPLINE <small>(Over Lifting Point)</small>																				
 RAISE BOOM	 LOWER BOOM	 MOVE SLOWLY	 RAISE THE BOOM AND LOWER THE LOAD																				
 LOWER THE BOOM AND RAISE THE LOAD	 SWING	 STOP	 EMERGENCY STOP																				
 TRAVEL	 DOG EVERYTHING	 TRAVEL <small>(ONE TRACK)</small>	 TRAVEL <small>(ONE TRACK)</small>																				
 EXTEND BOOM	 RETRACT BOOM	 EXTEND BOOM <small>(ONE HAND)</small>	 RETRACT BOOM <small>(ONE HAND)</small>																				
<p style="text-align: right;">7741365</p> <p style="text-align: center;"></p> <p style="text-align: center;">RELEASING OF SPRING-LOADED CYL.</p> <p style="text-align: right;">142</p>	<p style="text-align: right;">7741388</p> <p style="text-align: center;">140°F ——— 104°F ——— 68°F ——— 32°F ———</p> <p style="text-align: center;">143</p>	<p style="text-align: center;"></p> <p style="text-align: center;"> WARNING</p> <p style="text-align: center;">DO NOT TOUCH THE FAN</p> <p style="text-align: right;">7748462</p> <p style="text-align: center;">145</p>																					

DECAL KIT "USA"
 SCHILDERSATZ "USA"
 JEU DE PLAQUES "USA"

from No / up to No
 WFN5RUG###2036101
 WFN5RUG###2036135

Figure
 Bild 99707785896
 Figure

TADANO
 2830-20

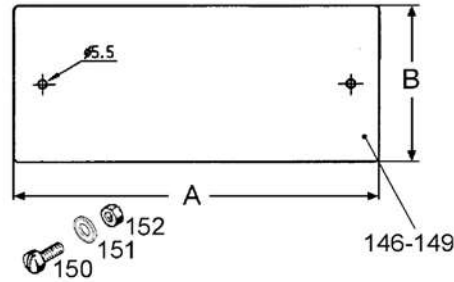

PLATES, PLATTEN, PLAQUES		
A	B	Item; Pos.; Réf
230mm	100mm	160
150mm	75mm	161
410mm	85mm	163
350mm	85mm	164
220mm	85mm	165
270mm	170mm	167

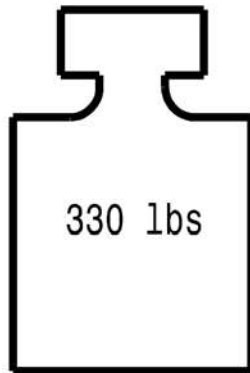

150

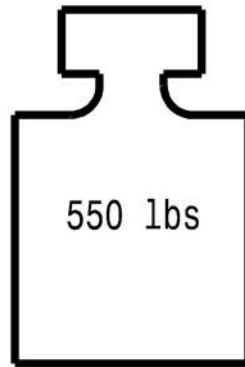

153



154

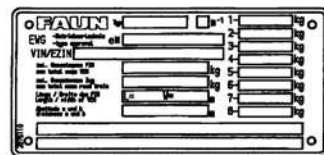

305

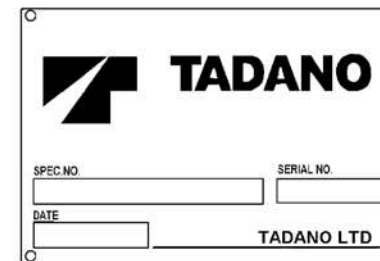

303